

INS-M12-N04N0-2C

Induktiver Näherungssensor
 Inductive proximity sensor
 Détecteur de proximité inductif

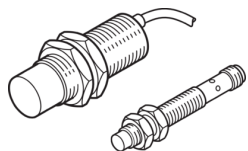

di-soric GmbH & Co. KG
 Steinbeisstraße 6
 DE-73660 Urbach
 Germany
 Tel: +49 (0) 7181/9879-0
 info@di-soric.com · www.di-soric.com



Stand 12.05.23, Änderungen vorbehalten
 As of 05/12/23, subject to change
 État 12.05.23, sous réserve de modifications

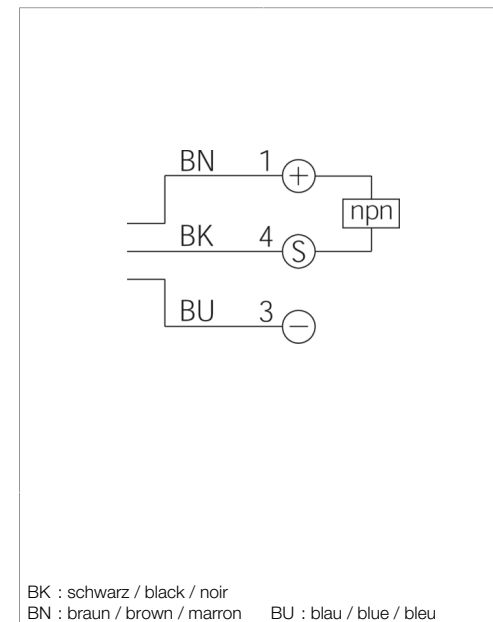
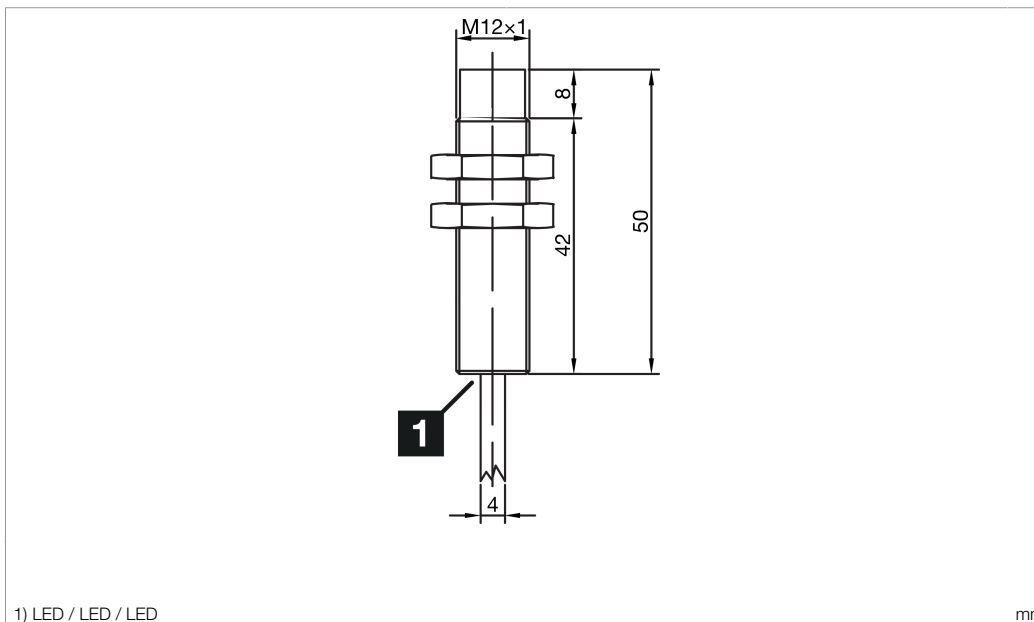

Technische Daten	Technical data	Caractéristiques techniques	+20°C, 24 V DC
Einbauart	Installation type	Type de montage	nicht bündig / non-flush / Non affleurant
Schaltabstand	Switching distance	Distance de commutation	4 mm
Betriebsspannung	Service voltage	Tension de service	10 ... 30 V DC
Schaltausgang	Switching output	Sortie de commutation	npn, 200 mA, NC
Auswertung	Evaluation	Évaluation	digital / digital / Numérique
Umgebungstemperatur Betrieb	Ambient temperature during operation	Température ambiante de fonctionnement	-25 ... +70 °C
Schutzart	Protection type	Indice de protection	IP 67
Anschluss	Connection	Raccordement	Kabel, 2 m / Cable, 2 m / Câble, 2 m

Sicherheitshinweise	Safety instructions	Consignes de sécurité
Allgemeiner Sicherheitshinweis WARNUNG! Kein Sicherheitsbauteil gemäß 2006/42/EG und EN 61496-1/-2! Darf nicht zum Personenschutz eingesetzt werden! Nichtbeachtung kann zu Tod oder schwersten Verletzungen führen! Nur bestimmungsgemäß verwenden!	General safety notice WARNING! Not a safety component pursuant to 2006/42/EG and EN 61496-1/-2! May not be used for personal protection! Non-compliance can lead to death or serious injuries! Only use as directed!	Consigne de sécurité générale AVERTISSEMENT ! Ce produit n'est pas un composant de sécurité au sens des réglementations 2006/42/CE et NF EN 61496-1/-2 ! Ne pas l'utiliser pour la protection des personnes ! Le non-respect de cette consigne peut entraîner la mort ou des blessures graves ! N'utiliser le produit que selon son utilisation conforme !

INS-M12-N04N0-2C

电感式接近传感器



di-soric GmbH & Co. KG
 Steinbeisstraße 6
 DE-73660 Urbach
 Germany
 Tel: +49 (0) 7181/9879-0
 info@di-soric.com · www.di-soric.com



版本 23.05.12, 保留变更权

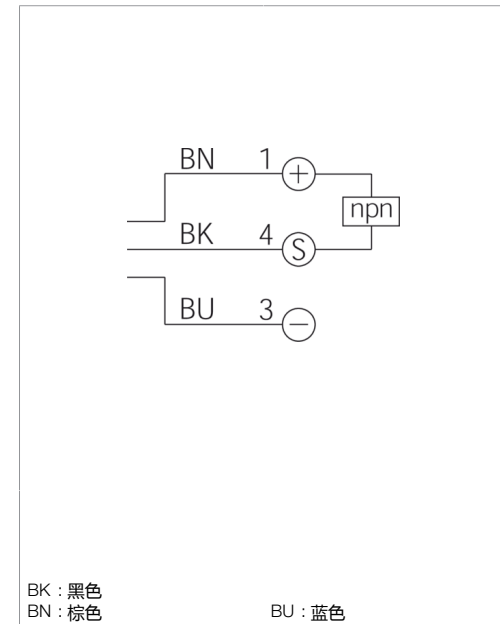
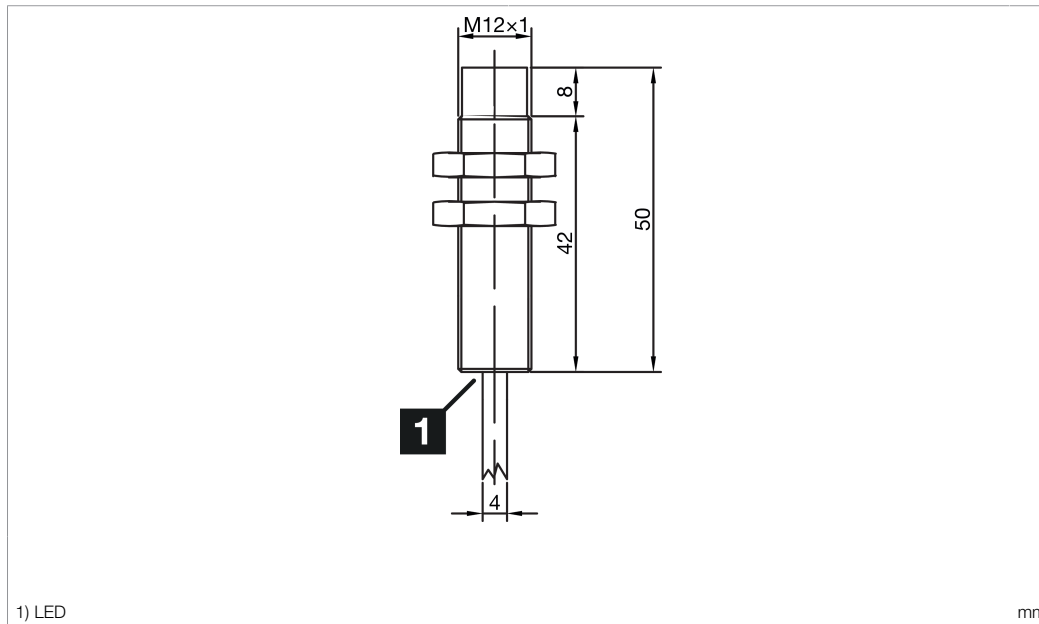

技术数据

内装方式

感应距离

工作电压

开关输出端

评估

工作环境温度

防护等级

连接

+20°C, 24 V DC

非齐平

4 mm

10 ... 30 V DC

npn, 200 mA, NC

数字量

-25 ... +70 °C

IP 67

电缆, 2 m

安全提示

一般安全提示

警告！ 没有符合 2006/42/EU 和 EN 61496-1/-2 标准的安全结构件！不得用于人身安全保护！不遵守规定会导致死亡或重伤危险！仅按规定使用！